

1	Beschlag		1
2	605*	296**	1
3	450*	296	1
4	450*	296	1
5	575	155	1
6	575*	296	1
7	605*	296**	1





# VCM.

service@vcm-gruppe.de

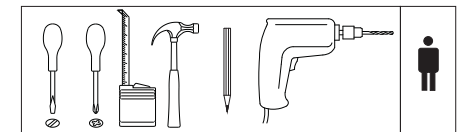
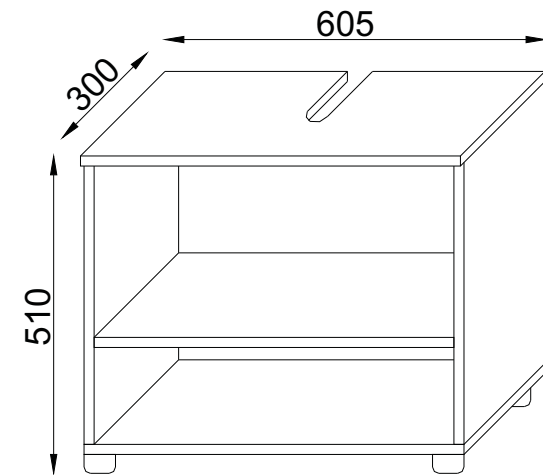
## Aufbauanleitung

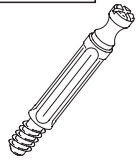
Artikel: **Waschbeckenunterschrank  
Offana**

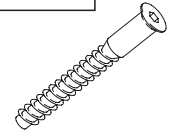
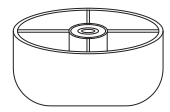
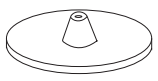
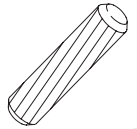
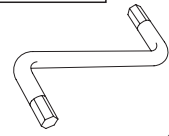
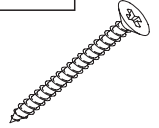

1.16  x5	1.17  x5	1.7  x13	1.11  x4
1.30  x5	1.14  x2	1.6  x1	1.49 3,5x30mm  x4
1.8  x9			

