

VCM.
my home

Medizinschrank Medasa L
Montageanleitung
Instruction manual

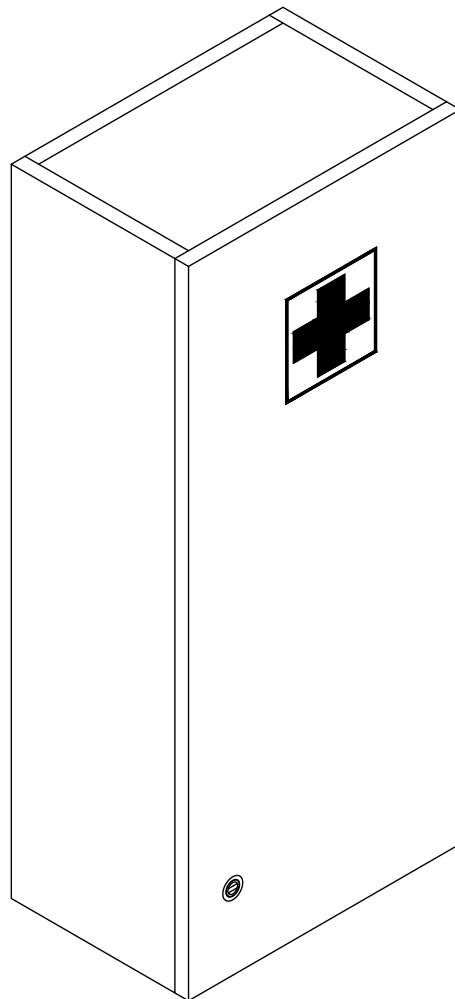

VCM Morgenthaler GmbH
D-79346 Endingen am Kaiserstuhl
service@vcm-gruppe.de
www.vcm-gruppe.de

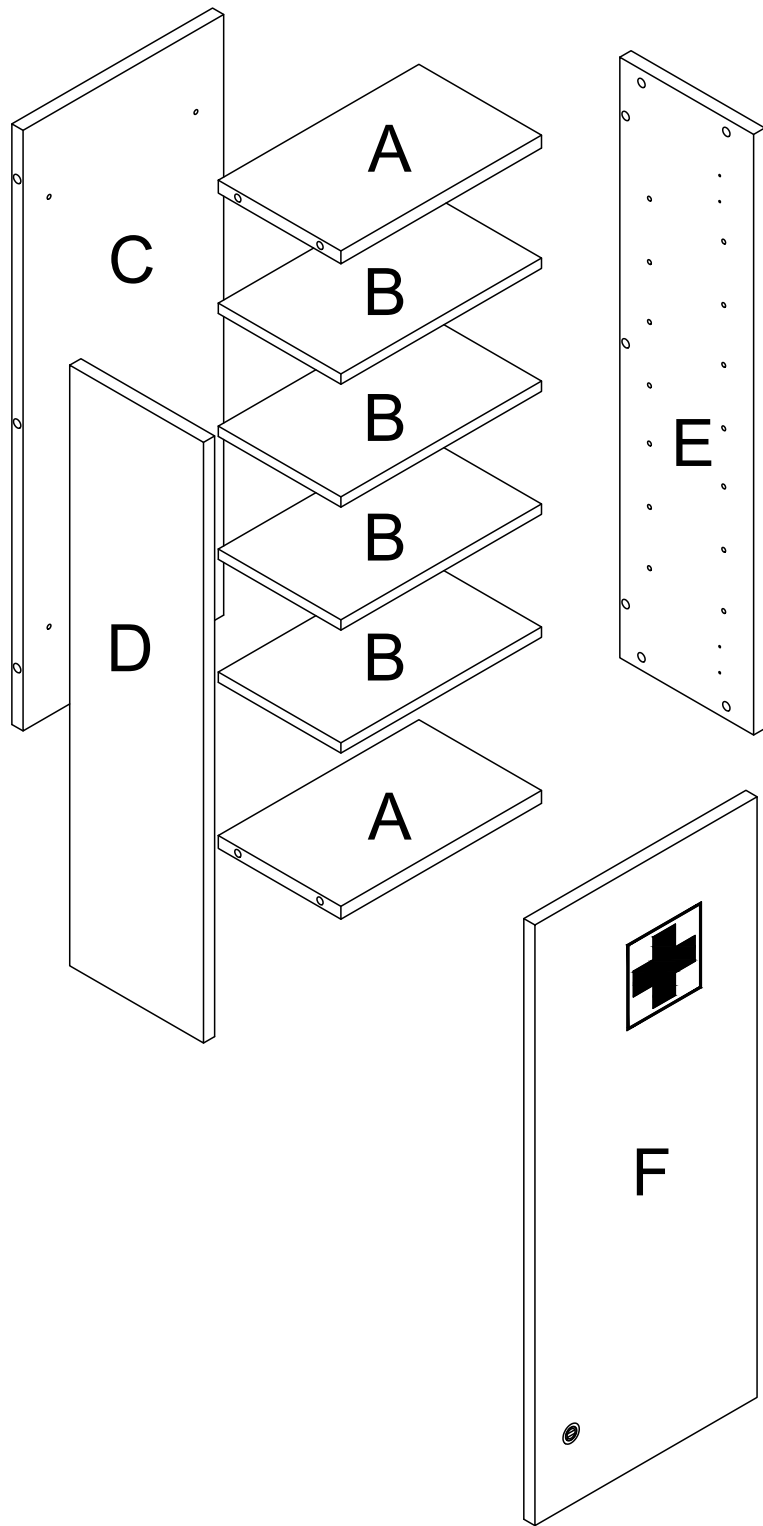



A 2x



B 4x

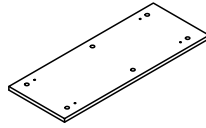

C 1x

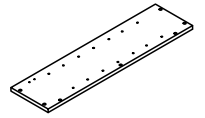

D 1x

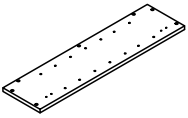

E 1x

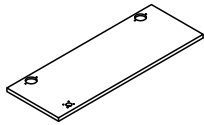

F 1x

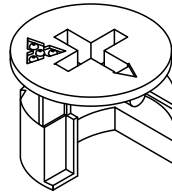

a 14x

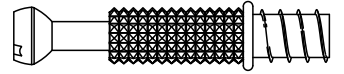

b 14x

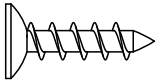

$\varphi 4 \times 14 \text{mm}$

c 18x

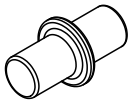

d 16x

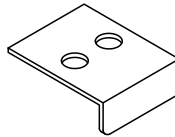

e 1x

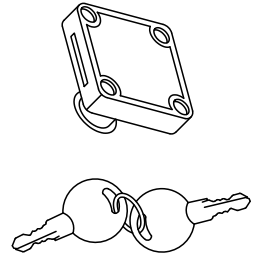

f 1x

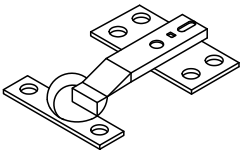

g 2x

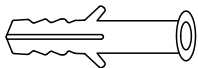

h 4x

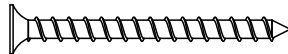

$\varphi 4 \times 45 \text{mm}$

i 4x

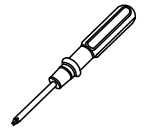

j x1



k 1x

1

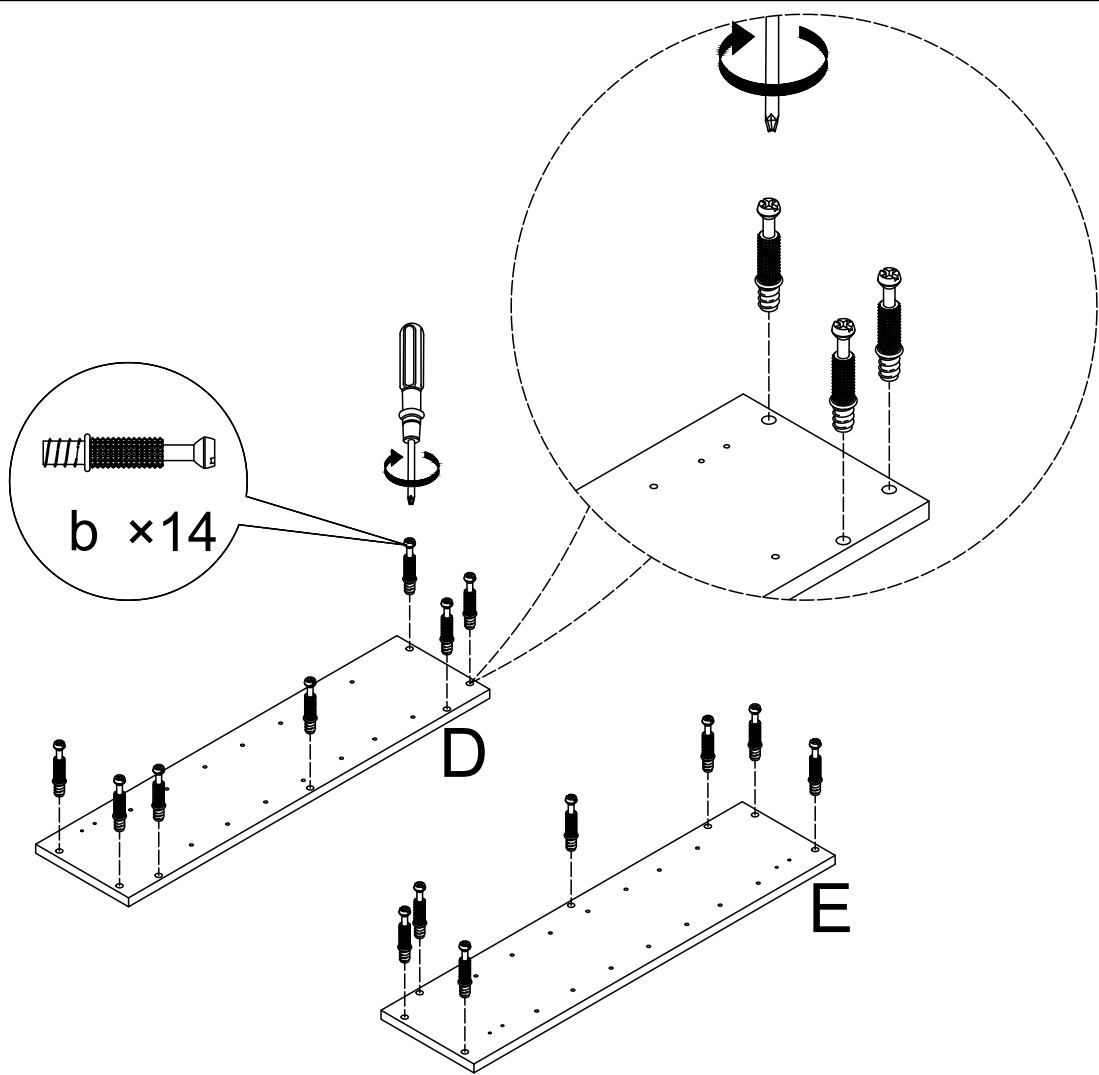

2

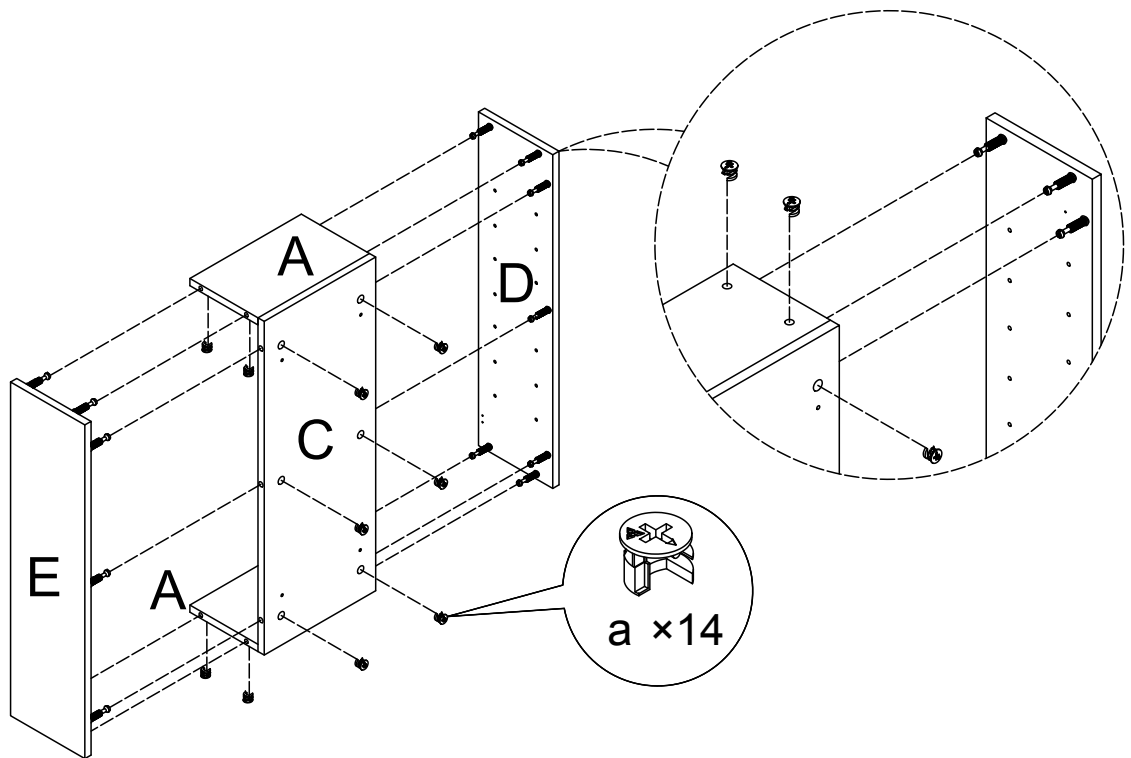

3

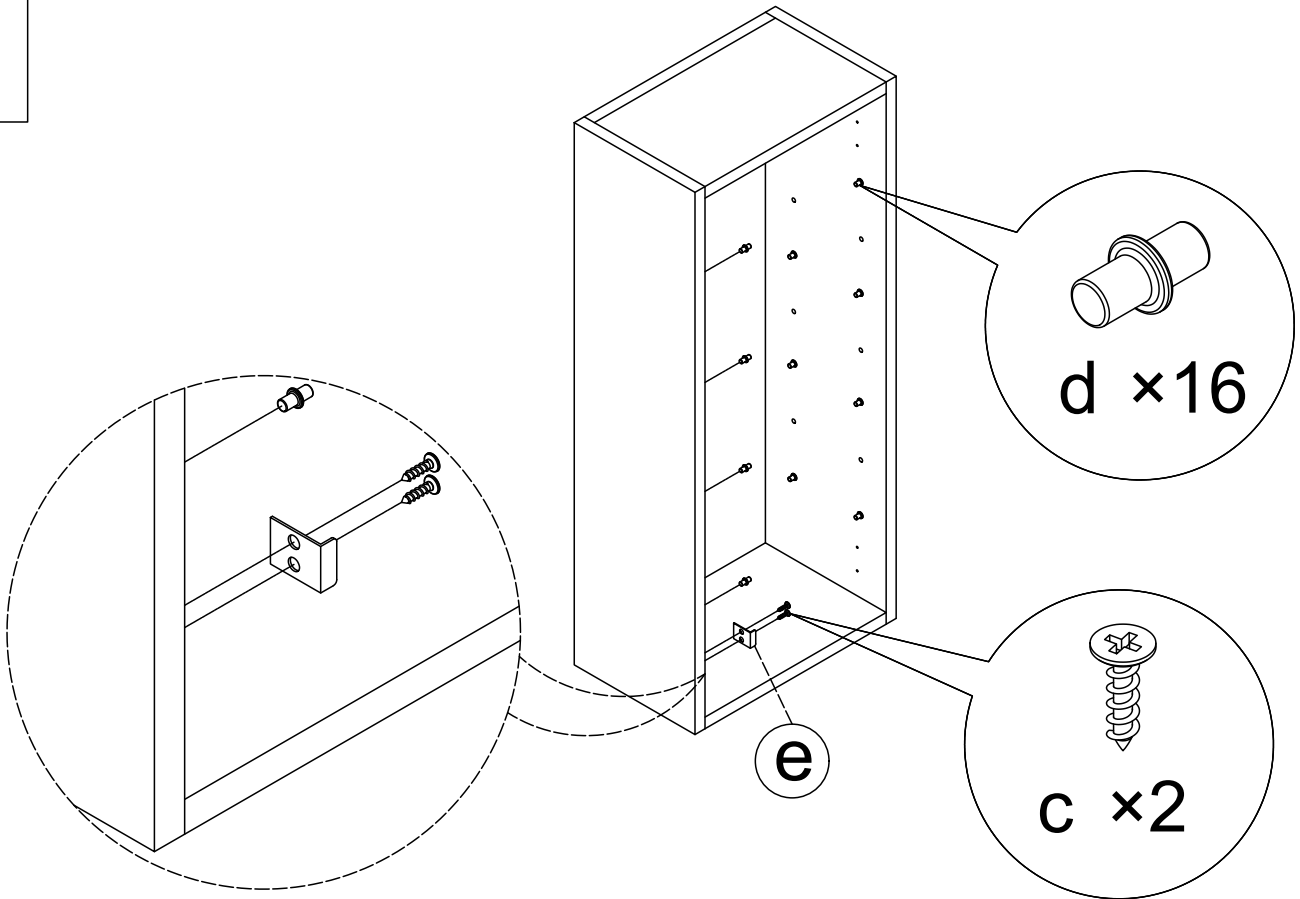

4

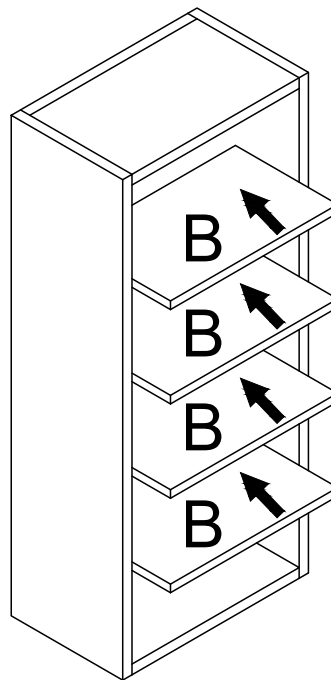

5

5

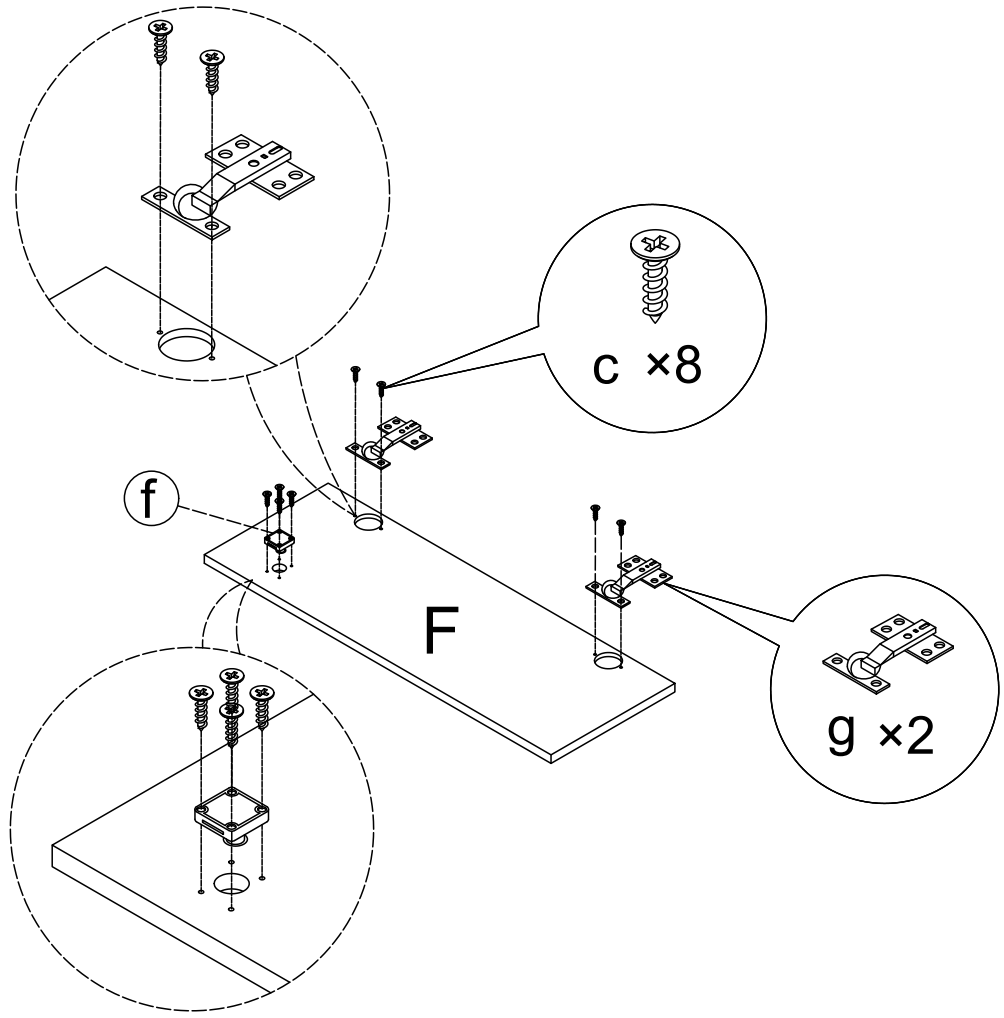

6

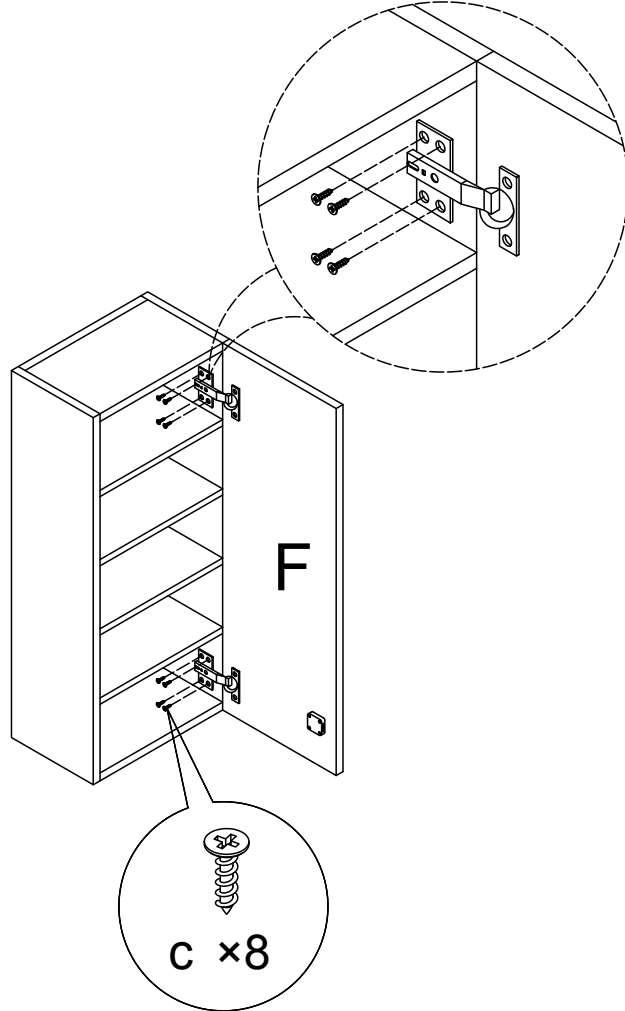

6

7

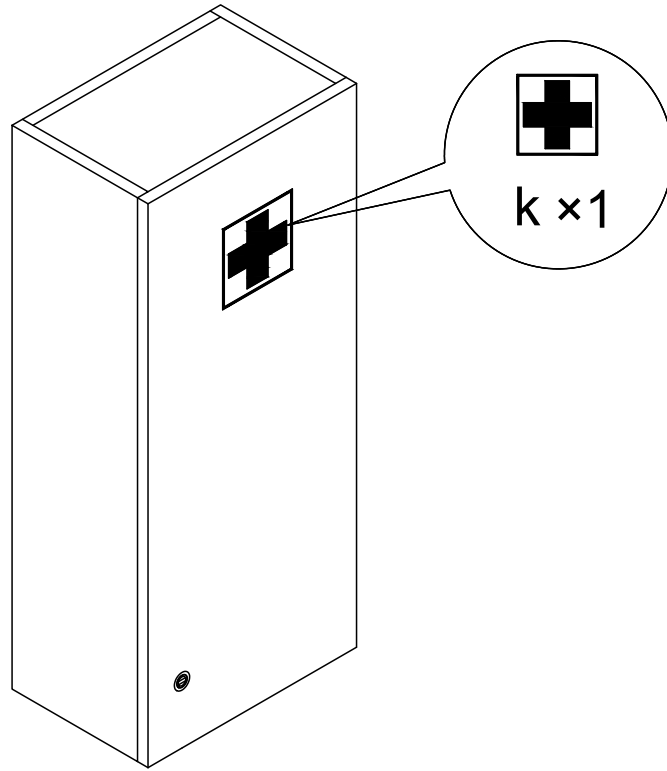

8

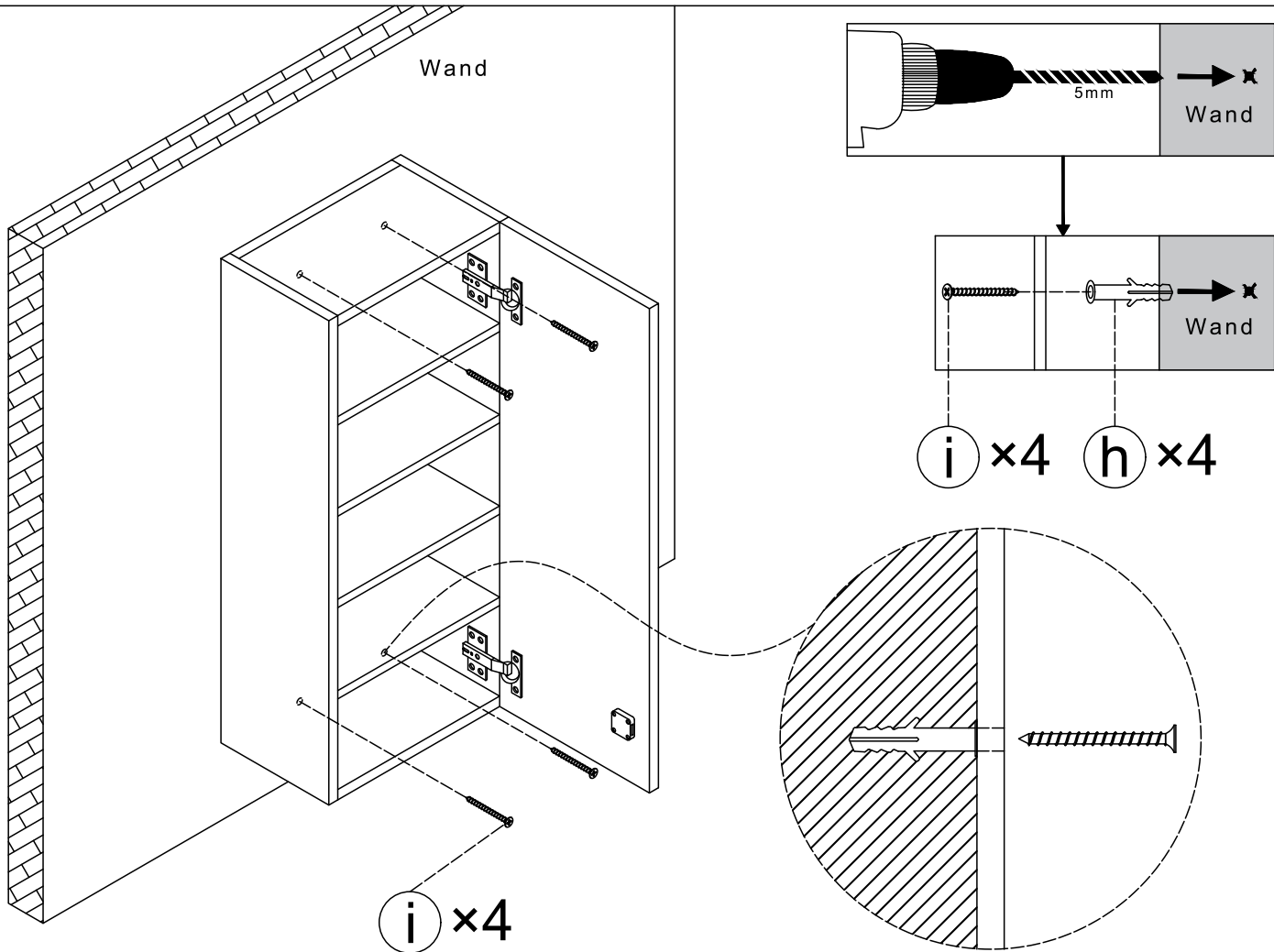

7